







































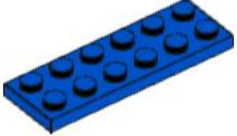

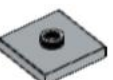

nwbricks  
GYRO-CART



[instagram.com/nwbricks](https://www.instagram.com/nwbricks)  
[northwestbricks.co.uk](http://northwestbricks.co.uk)

85 pcs

- |   |  |   |  |  |   |   |   |
|---|--|---|--|--|---|---|---|
| <br>2x<br>4081b, 11  | <br>1x<br>2926, 11    | <br>4x<br>85861, 1   | <br>1x<br>4589b, 5    | <br>1x<br>3021, 88        | <br>1x<br>3795, 88     | <br>2x<br>25386, 2     | <br>4x<br>48336, 115 |
| <br>1x<br>3023, 11   | <br>2x<br>4095, 11    | <br>1x<br>20482, 1   | <br>6x<br>4073, 88    | <br>4x<br>30374, 88       | <br>1x<br>24866, 6     | <br>1x<br>24866, 36    |   |
| <br>2x<br>23969, 11  | <br>1x<br>23969, 86   | <br>1x<br>15496, 1   | <br>2x<br>15712, 88   | <br>1x<br>93273, 88       | <br>2x<br>2470, 8      |   |   |
| <br>1x<br>60470b, 11 | <br>1x<br>3004, 86    | <br>1x<br>4589b, 1   | <br>1x<br>3023, 88    | <br>2x<br>3069b, 68       | <br>6x<br>11477, 7     |   |   |
| <br>1x<br>48336, 11  | <br>1x<br>4032, 86  | <br>1x<br>38014, 1   | <br>2x<br>33909, 88   | <br>2x<br>3710, 88        | <br>2x<br>98283, 68    | <br>1x<br>3795, 7     |   |
| <br>1x<br>3020, 11 | <br>1x<br>87580, 86 | <br>1x<br>35480, 1 | <br>2x<br>99207, 88 | <br>1x<br>87079pb810, 88 | <br>1x<br>49309, 150 | <br>1x<br>20482, 12  |   |
|   |  | <br>6x<br>11477, 1 | <br>2x<br>3623, 88  | <br>2x<br>3020, 88      |   | <br>4x<br>85861, 115 |   |

1

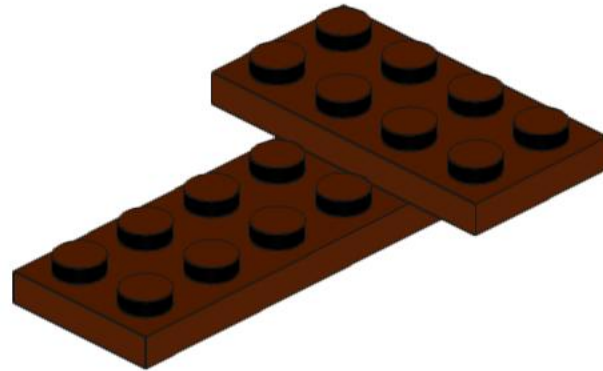
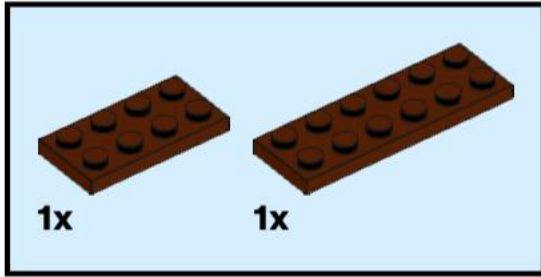

2

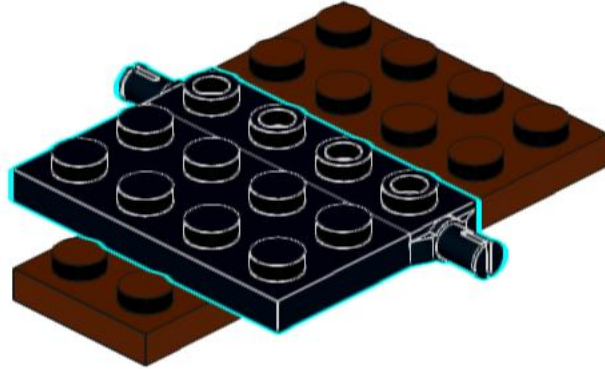
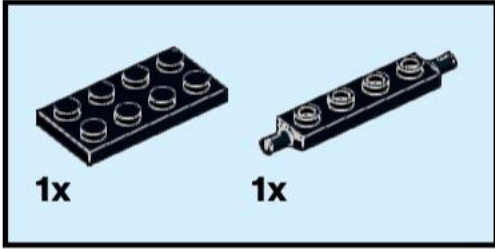

3

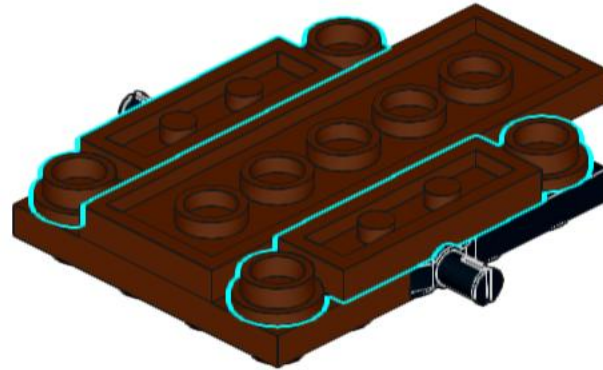
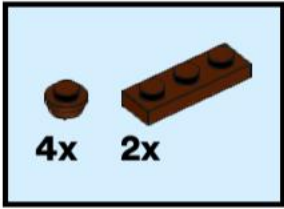

4

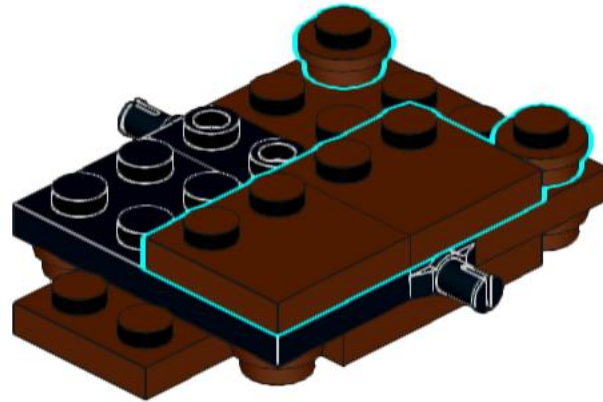
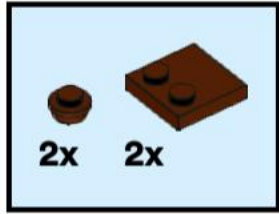

5

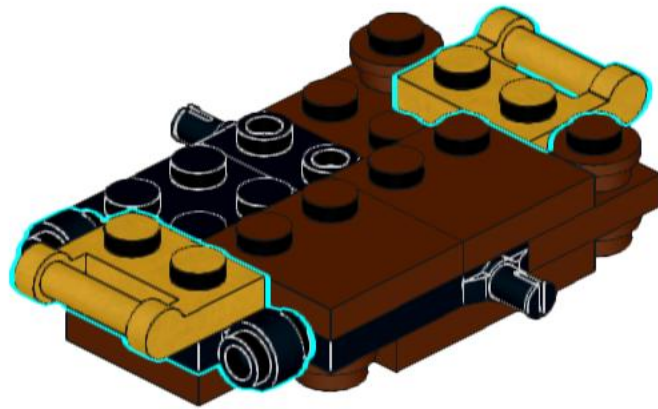
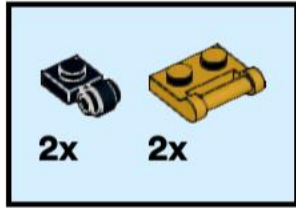

6

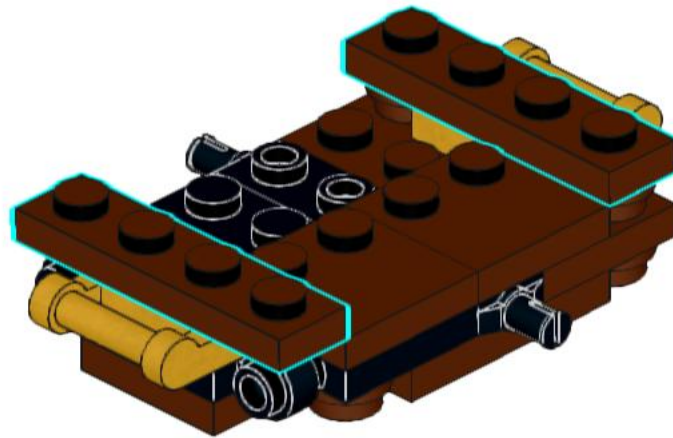
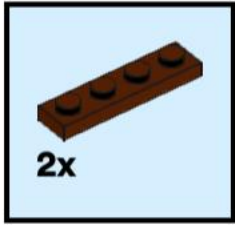



7

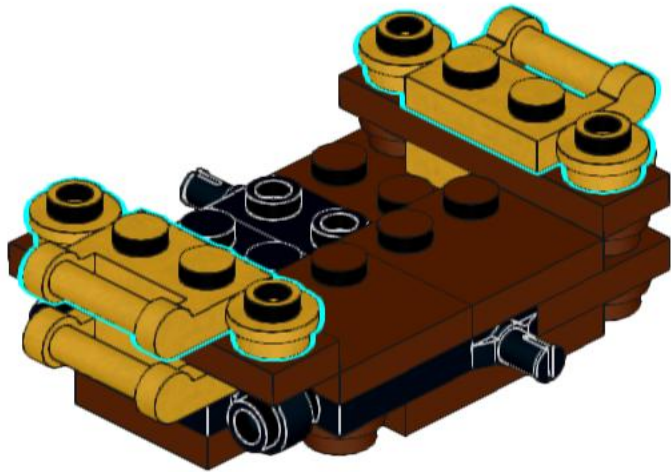
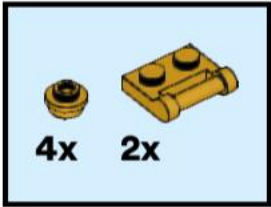

8

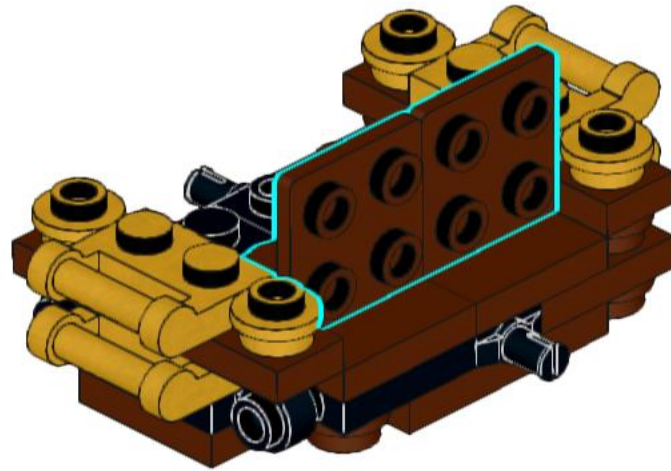
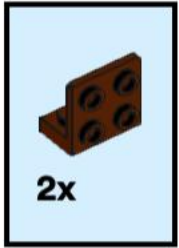

9

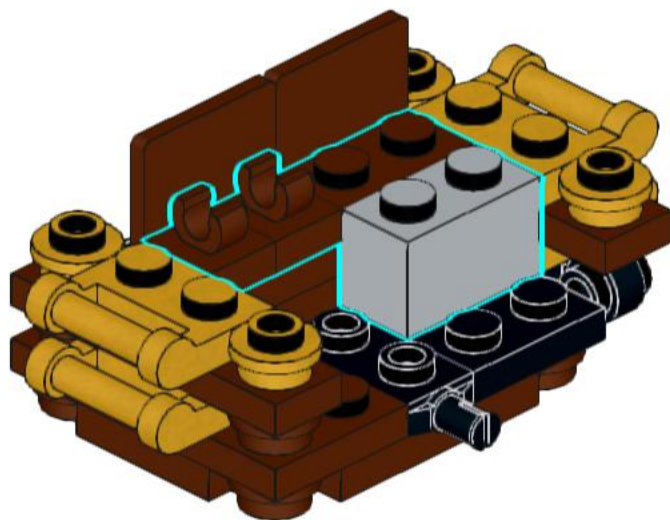
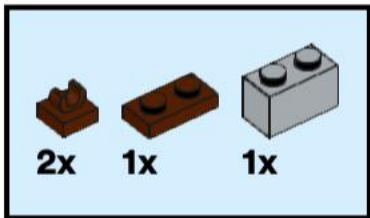

10

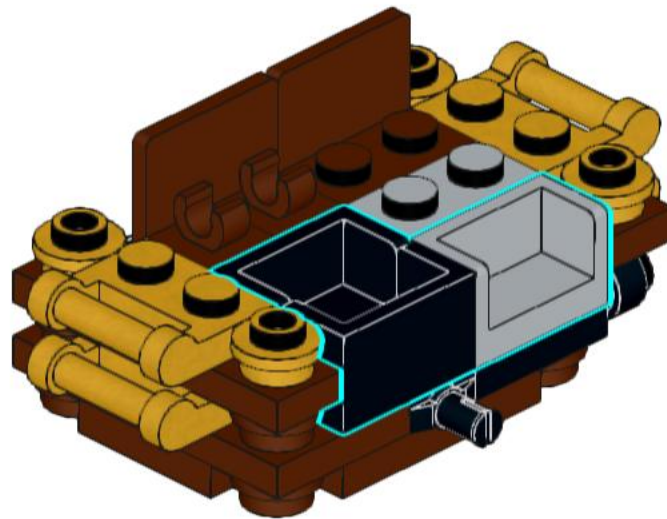
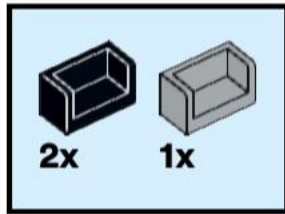

# 11

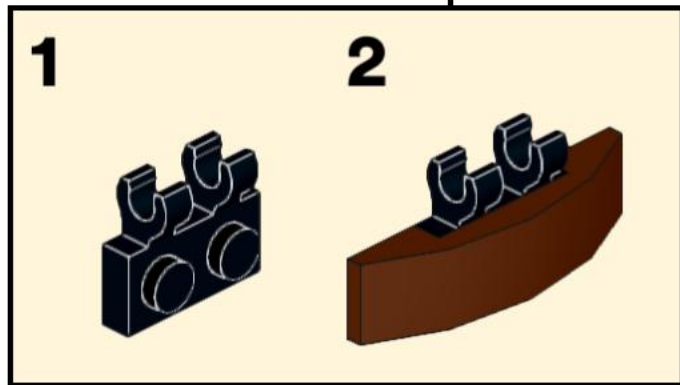
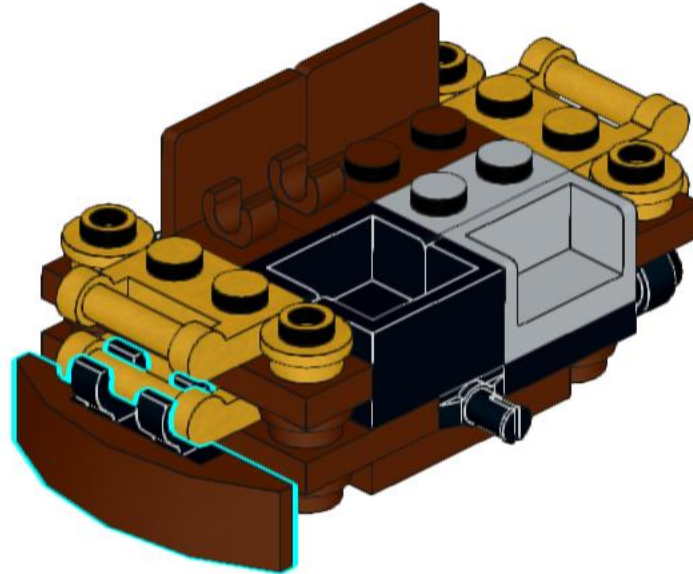
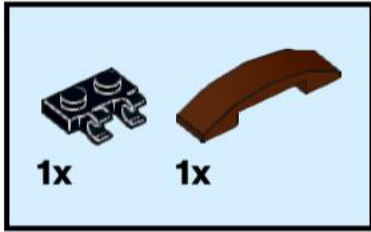

# 12

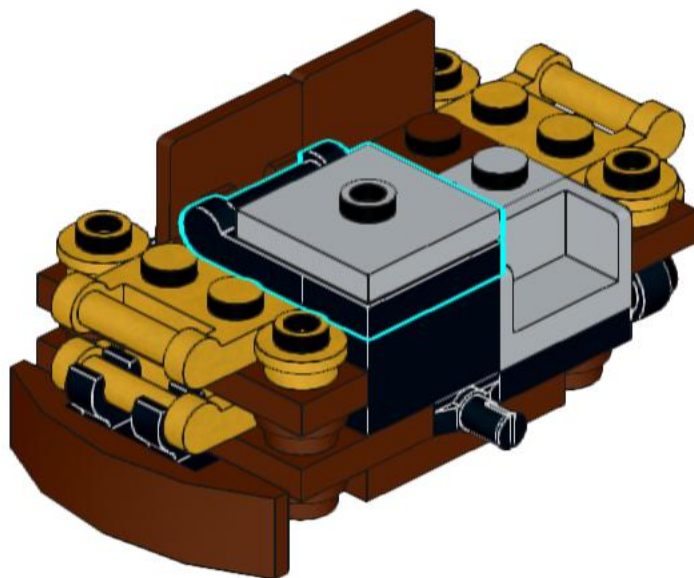
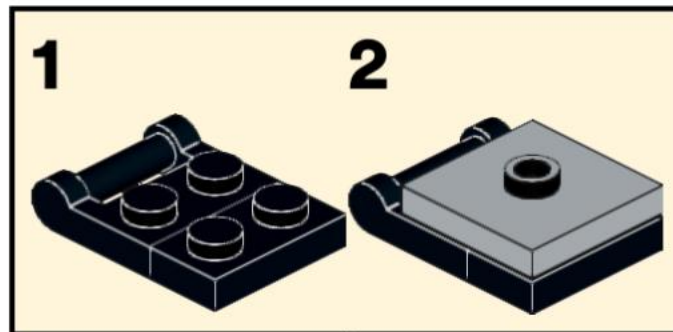
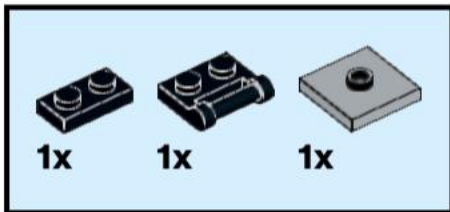

# 13

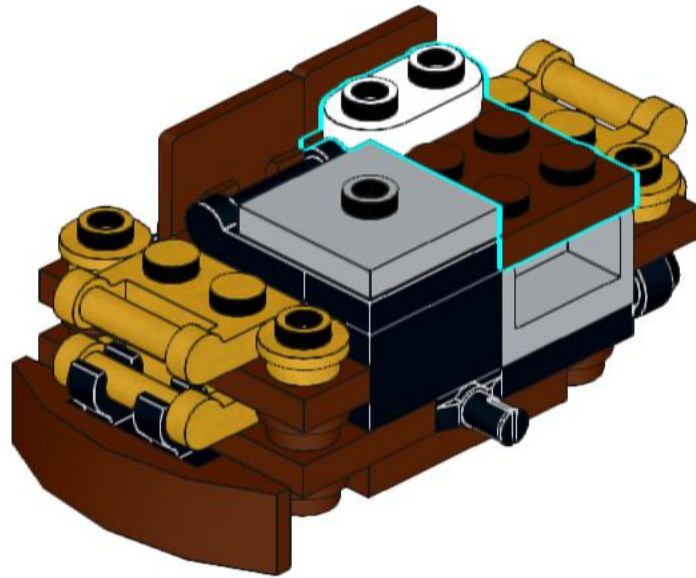
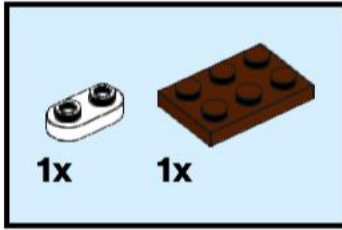

14

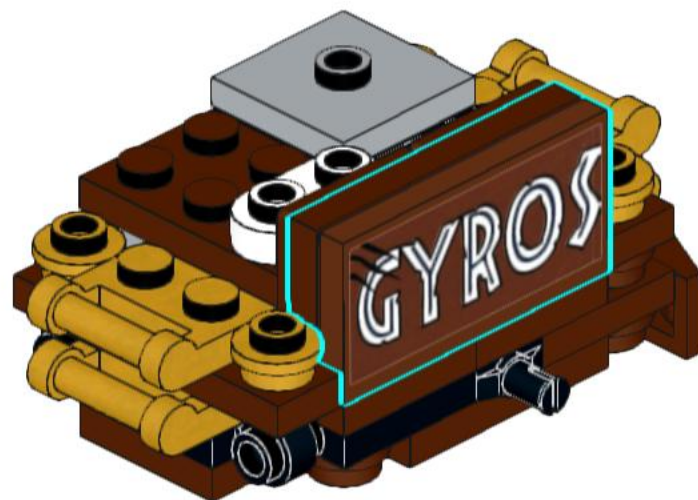
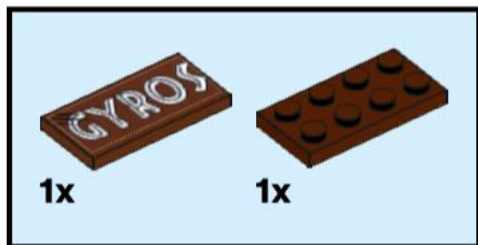



15

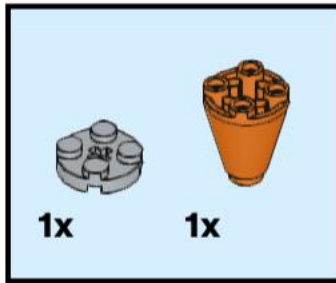

# 16

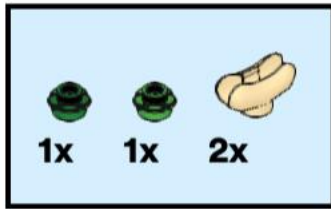

17

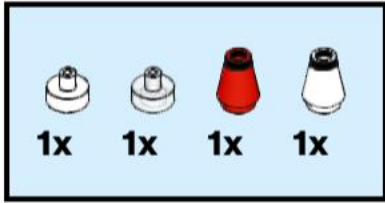

18

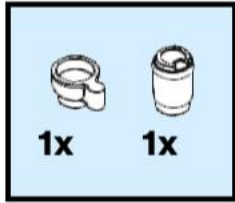

# 19

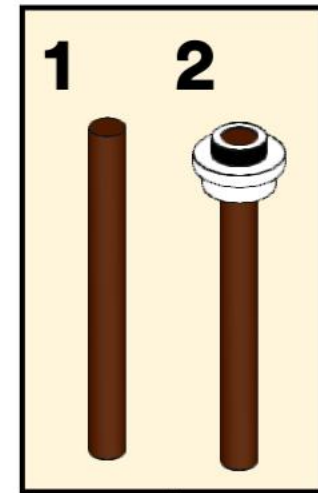
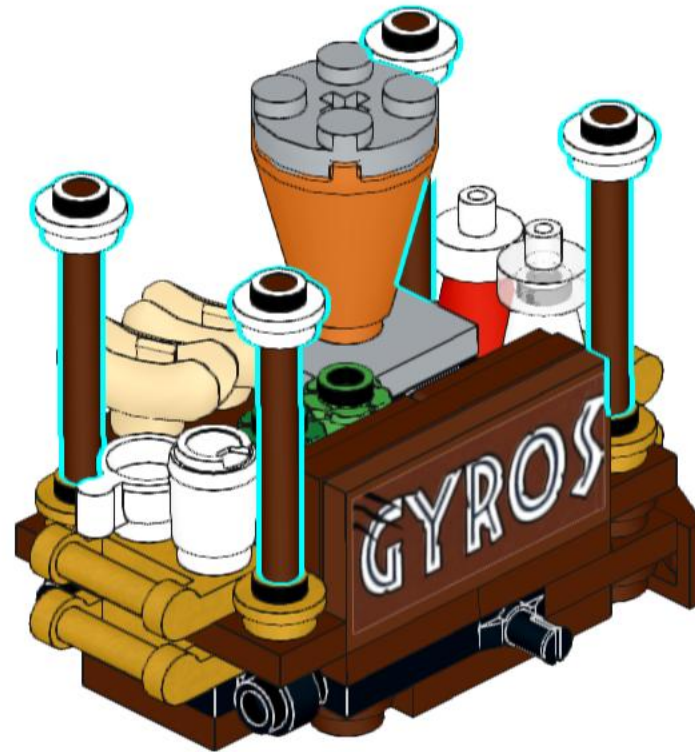
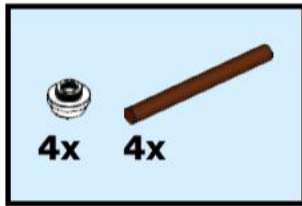

4x



# 20

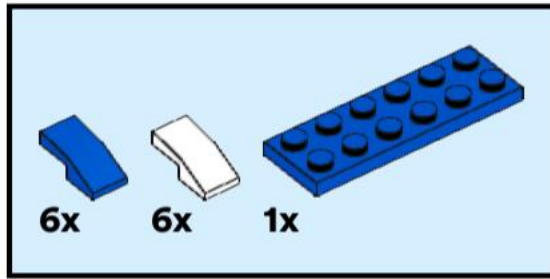

1

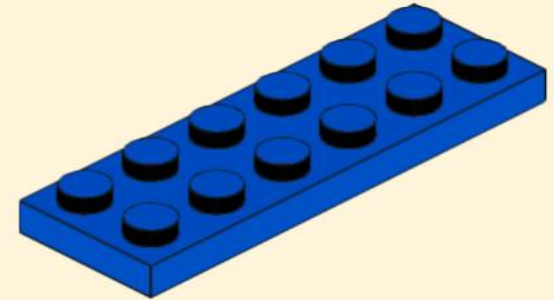

2

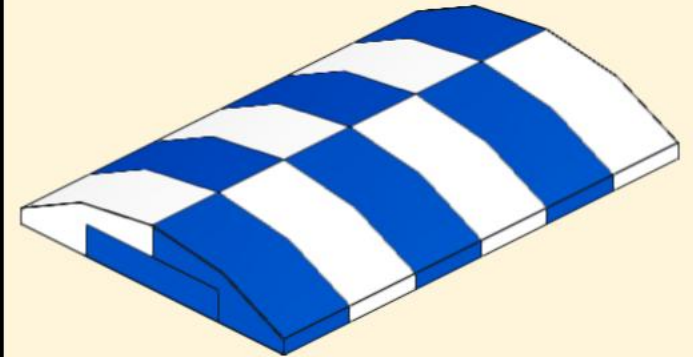

21

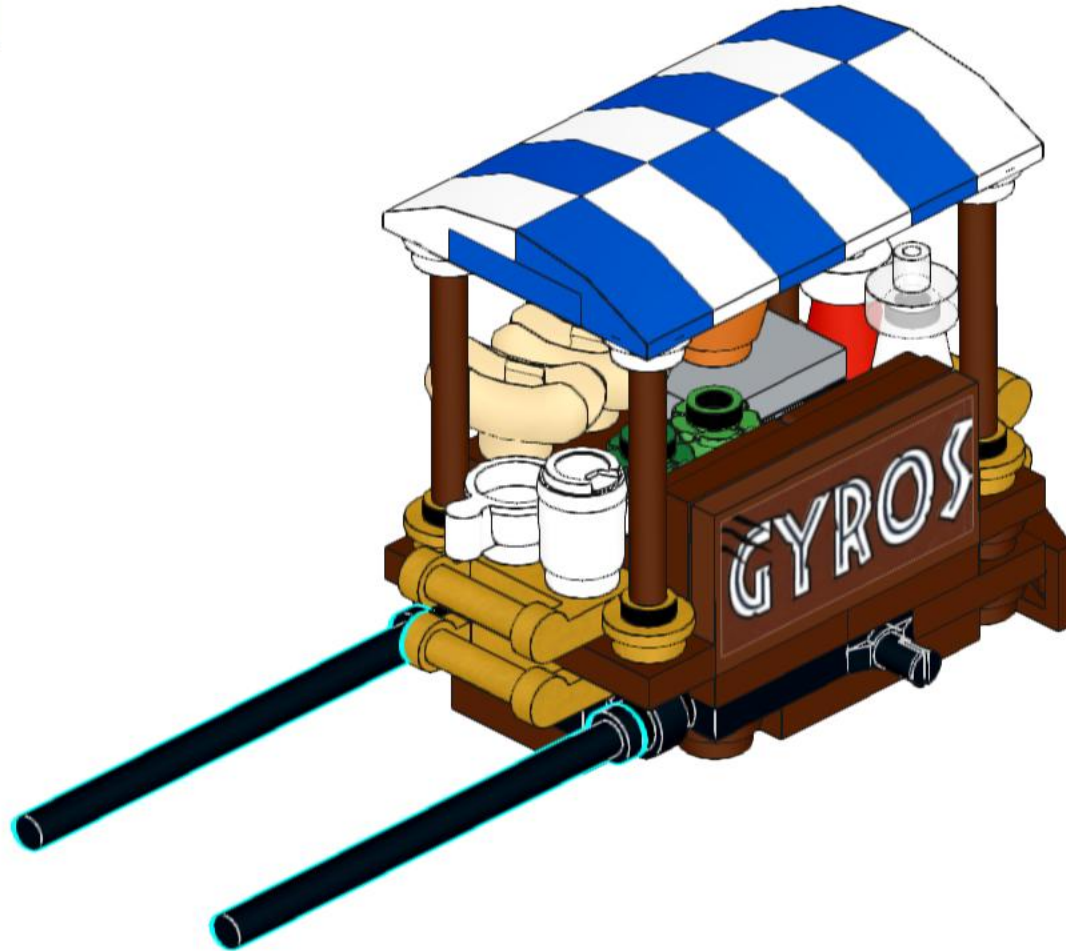

# 22

